

Brandschutzabstände (Angaben in cm)

Panorama Serie

P10-Serie

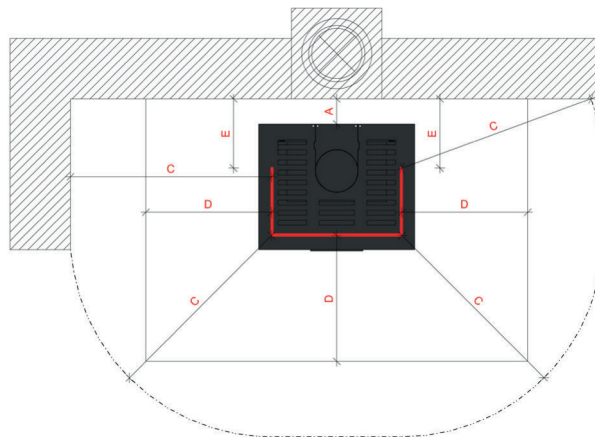

Hintere Wand (A)	zu schützen = 0
Seitliche Wand (B)	zu schützen = 0
Strahlung Scheibe (C)	zu schützen = 80
Boden	zu schützen = 0
Decke	zu schützen = 70
Funkenschutz (D)	vor der Tür = 50
Funkenschutz (E)	seitlich/hinten zur Tür = 30